



Car CD/MP3 Radio + Bluetooth

User's Guide



After Sales Support

Now you have purchased a Tevion product you can rest assured in the knowledge that as well as your 3 years parts and labour warranty you have the added peace of mind of dedicated helplines and web support:

AFTER SALES SUPPORT

UK / N.IRELAND HELPLINE NO 01270 508538

REP. IRELAND HELPLINE NO 1800 995 036

WEB SUPPORT www.qesh.co.uk

MODEL NUMBER: 43744

Contents

Welcome Section.....	3
Precautions.....	4
Before You Install.....	5-6
Installation.....	7-8
Wiring Connection.....	9
Location of the Controls.....	10
Remote Control.....	11
Basic Operation.....	12
Radio Operation.....	13-14
Bluetooth Operation.....	15
CD/MP3/WMA/USB/SD Operation.....	16-17
ID3 TAG.....	17
RCA, AUX & SUB.....	18
FAQ.....	18
Warranty.....	19

Welcome!

Congratulations on choosing to buy a Tevion® product. By doing so you now have the assurance and peace of mind that comes with purchasing a product made by one of Europe's leading manufacturers. All products brought to you by Tevion® are manufactured to the highest standards of performance and safety, and, as part of our philosophy of customer service and satisfaction, are backed by our comprehensive 3 Year Warranty. We hope you will enjoy your purchase for many years to come.

DISPOSAL OF YOUR OLD PRODUCT

Electric and electronic equipment (EEE) contains materials, parts and substances which can be dangerous to the environment and harmful to human health if not disposed of correctly. Please contact your local authority for details of correct disposal operating in your area. The product should not be disposed of in household waste.



DISPOSAL OF BATTERY FROM THE REMOTE CONTROL
Do not dispose of used batteries in household waste. Please contact your local authority for details of disposal / recycling schemes in your area.



Precautions

- This unit will only play the following discs.
- This unit does not play files that have Digital Rights Management (DRM).
- If you have files that have Digital Rights Management (DRM) you should consult with the vendor that you purchased files from for instructions on proper use.

Type of disc	Label on the disc	Recorded material	Size of disc
CD, MP3, WMA		Audio only	12 cm

Never allow children to play with electrical equipment

Care of Discs

Handle the disc by its edge to keep the disc clean. Do not touch the disc's surface.



Do not use CDs with labels or stickers attached. The label may leave a sticky residue when it begins to peel.



Do not use a CD with paste or ink residue on it.



Clean the discs with an optional cleaning cloth. Wipe each disc from the centre out.



Before You Install

IMPORTANT: Remove the two transport screws from the top of the unit before installing.

Please remove the screws before installing the radio; Failure to do so will result in the CD deck rejecting the disc. Please refer to the illustration below:

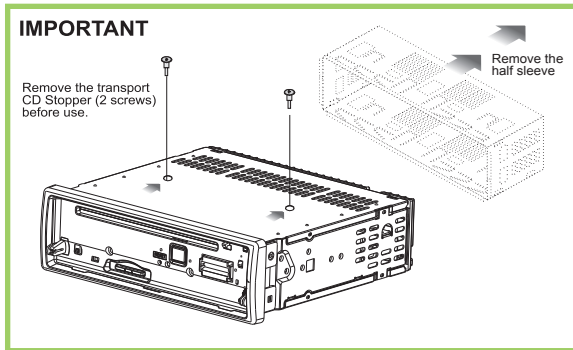

Notes on Installation

- Disconnect negative battery terminal before starting installation. Consult the vehicle owner's manual for proper instruction.
- The unit is designed for a 12Volt DC negative ground operation system only. Before installing the unit, make sure your vehicle is a 12Volt DC negative ground system.
- Be sure to connect the colour coded leads according to the diagram. Incorrect connections may cause the unit to malfunction or damage the vehicle's electrical system.
- Be sure to connect the negative (-) speaker leads to the negative (-) speaker terminal.
- Never connect negative (-) speaker leads to chassis ground.
- The unit is only designed for use with 4 speakers. Do not combine output for use with 2 speakers. Do not ground negative speaker leads to the chassis ground.
- Make sure all the connections are completely correct before turning on your unit.
- When replacing the fuse(s), the replacement must be of the same amperage as shown on the fuse holder.
- Do not block vents or heater panels. Blocking them will cause heat to build up inside and may result in fire.
- After completing the installation and before operating the unit, reconnect the battery. Then press the (RES) button with a pointed object, such as a ball-point pen to set the unit to its initial status.
- If you have difficulty installing this unit in your vehicle. Please contact your dealer.

Before You Install

Car audio equipment installations can be troublesome at times, even to the most experienced of installation technicians. If you are not confident working with electrical wiring, removing and reinstalling interior panels, carpeting, dashboards or other components of your vehicle, please call your dealer in order to have the unit professionally installed.

Remove the Old Unit from the Dashboard

1. Remove the outer trim frame.

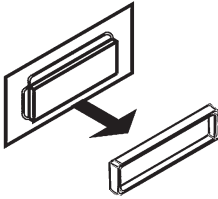

DIN Front Mount

2. Insert the keys supplied with the old unit into both sides of the unit as shown in figure below until they click. Pull to remove the old unit from the dashboard.

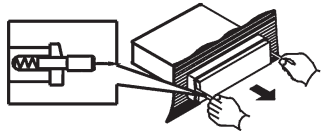

DO NOT DISCONNECT WIRES AT THIS TIME!

2. Mark Polarity of the Speaker Wires

Marking the polarity of the speaker wires will make it easier to connect the existing speakers to your car radio. Consult wiring diagram of existing head unit before disconnecting any wires. If you are not positive of the polarity of the existing wires from the speakers to the head unit, install new wires.

- a. While the old unit is playing, disconnect the wires from one speaker.
- b. Take a length of masking tape and fold it around the wire so it forms a flag.
- c. On the masking tape mark the polarity of the speaker wires (+ & -), as well as left or right, and front or rear.
- d. Double check that you marked the first speaker correctly by checking that the speaker wires are the same at the head unit.
- e. Repeat this procedure for all of the speakers.
- f. Mark the power, ground, and any other wires also.

Installation

WARNING!

Disconnect negative battery terminal from battery before starting installation. Consult the vehicle owner's manual for proper instructions.

NOTE 1:

Mark the polarity of the existing speaker wires before disconnecting battery.

NOTE 2:

Remove the two transport screws from the top of the unit before installing.

DIN Front Mount

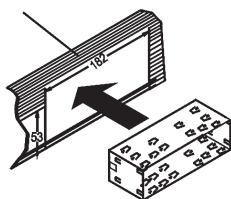

1. After removing the old radio and mounting sleeve, insert supplied mounting sleeve into opening.

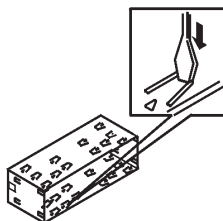

2. Bend the tabs on the mounting sleeve to keep the mounting sleeve firmly in place.

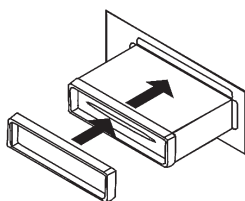

3. Attach wires from the unit to existing wires. See wiring connections diagram. Insert radio into dashboard. Then apply the trim frame to outside of radio.

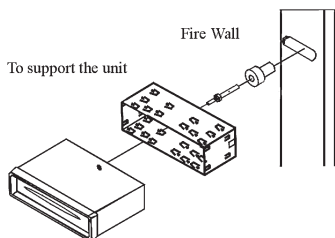

4. Support radio using supplied rear mounting bolt and steel bar. See parts list.

Installation

Din Rear-Mount

Installation using the screw holes on both sides of the unit.

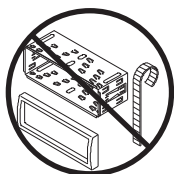
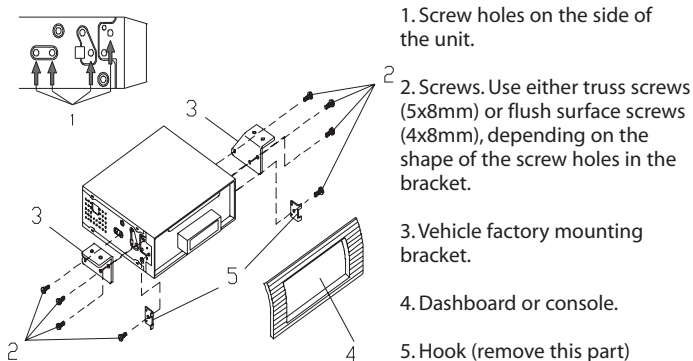

Note: The mounting sleeve, outer trim ring and the mounting strap are not used for this method of installation.

Supplied Parts

- 2 Keys
- 1 Hex Nut
- 2 Lock Washers
- 1 Sheet Metal Screw
- 1 Metal Support Strap
- 2 Flat Washers
- 1 Mounting Bolt
- 1 Faceplate Case (not shown)
- 1 1/8" Stereo Cable
- 1 USB Extension Cable
- 1 Remote Control



Wiring Connection

Make sure that you have a good chassis ground. Good ground connections will eliminate most electrical noise problems. A good chassis ground requires a tight connection to the vehicle's metal chassis. The area around the ground connection should be clean, bare metal without rust, paint, plastic, dust, or dirt for a good electrical connection.

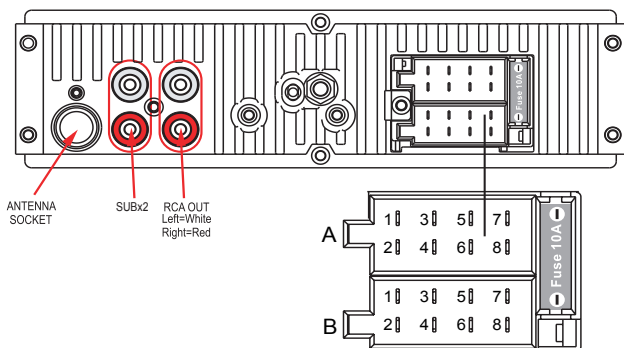

Connector A

1. Rear right speaker(+)/Blue
2. Rear right speaker(-)/Blue-White
3. Front right speaker(+)/Grey
4. Front right speaker(-)/Grey-White
5. Front left speaker(+)/Green
6. Front left speaker(-)/Green-White
7. Rear left speaker(+)/Brown
8. Rear left speaker(-)/Brown-White

Connector B

1. -
2. -
3. -
4. Battery 12V (+)/Yellow
5. Antenna power/Orange
6. Panel light/White
7. ACC+/Red
8. Ground/Black

Speaker Wiring Notes

Follow the above wiring diagram to install the head unit with new or existing speakers.

This unit is designed for use with four (4) speakers with an impedance between 4 Ohms to 8 Ohms.

An impedance load of less than 4 Ohms could damage the unit.

Never bridge or combine the speaker wire outputs. When not using four speakers, use electrical tape to tape the ends of the un-used speaker outputs to prevent a short circuit.

Never ground the negative speaker terminals to chassis ground.

Location of the Controls

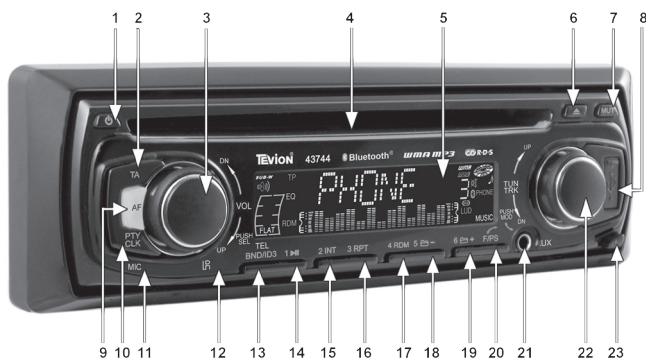

1. Power on / off
2. TA
3. Sound Select / Volume +/-
4. Disc Slot
5. LCD Screen
6. Eject
7. Mute
8. USB Slot
9. AF
10. PTY/Clock
11. MIC Receiver
12. Remote Control Receiver
13. Band / ID3 / Phone
14. Number1 / Pause
15. Number2 / Introduction
16. Number3 / Repeat
17. Number4 / Random
18. Number 5 / Folder Down
19. Number 6 / Folder Up
20. Auto Preset Scan / Reject Button
21. Aux input Jack
22. Mode Select / Answer Button
23. Release Panel Button
24. SD Card Slot
25. Reset Button

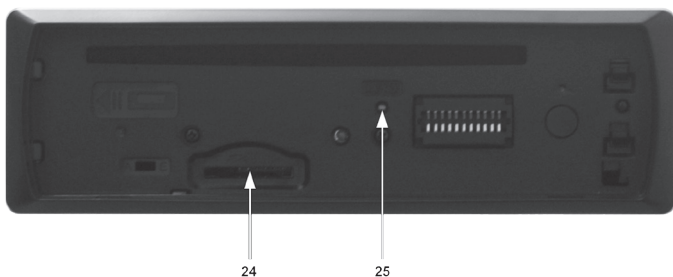

Remote Control

Operating the remote control

Aim at the face panel of the CD receiver, the maximum distance at which signals can be received is about 6 meters. Make sure that the signal path is not obstructed.

Battery Safety

Take care when fitting batteries, observing the polarity marking on the battery and the product.

Never dispose of batteries in fire. Risk of explosion.

Never attempt to recharge non-rechargeable batteries.

Seek immediate medical advice if you believe a cell has been swallowed.

Keep batteries away from children.

Remove batteries from a product if it is not to be used for a period of time.

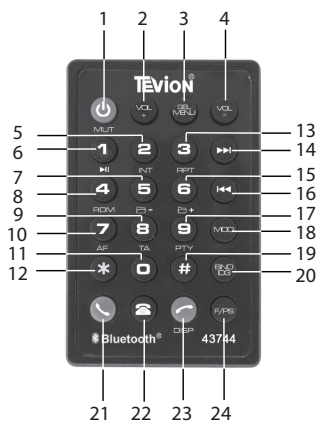

1. Power on / off / Mute Sound Button
2. Volume +
3. Sound Select Key / Menu
4. Volume -
5. Number 2 / Intro Scan
6. Number 1 / Play / Pause
7. Number 5 / Folder Down
8. Number 4 / Random Play
9. Number 8 / TA Control
10. Number 7 / AF Control
11. Number 0
12. Number *
13. Number 3 / Repeat Play
14. Stations Tune/Seek/Track Up
15. Number 6 / Folder Up
16. Stations Tune / Seek / Track Down
17. Number 9 / PTY Control
18. Mode
19. Number #
20. Band / ID3
21. Answer Button
22. Phone Button
23. Reject Button / Clock Display
24. F/PS

To replace the batteries:

Follow the 3 steps below:

(1) Remove the cover from the back of the remote control.

(2) Insert a CR-2025 Lithium battery.

(3) Replace the cover on the back of the remote control.



Basic Operation

1. Tuning the unit On / Off

Press any Button to turn the unit on, the display will show a message WELCOME to indicate it is ready for use. Press and hold the POWER/MUTE button for 2seconds to turn the unit off. The display will show a message GOODBYE.

2. Mode Selection

Press the MODE Button to cycle the Play Mode among AUX, RADIO and CD PLAY.

Note: USB mode will only show on the display when a USB flash memory is inserted into the USB port.

3. Loudness Control

Press the SEL button until "LOUD OFF" is shown on the display indicates that the loudness function is OFF. Turn the volume knob to select between ON or OFF.

4. Subwoofer Control

Press the SEL button until "WOOF OFF" is shown on the display indicating that the subwoofer is OFF. Turn the volume knob to select between ON or OFF.

5. Mute Control

Press the POWER/MUTE button once to activate the MUTE function. Press the button again or use the VOL +/- Button to cancel.

6. Volume

Use the VOL +/- Button to adjust the volume level. The larger the number, the higher the volume level.

7. Bass

Press the SEL Button repeatedly until the display shows "BAS". Use the VOL +/- Button to adjust. When EQ is ON, bass control is not available.

8. Treble

Press SEL Button repeatedly until the display shows "TRE". Use the VOL +/- Button to adjust. When EQ is ON, treble control is not available.

9. Balance

Press SEL Button repeatedly until the display shows "BAL L-R"; then use the VOL +/- Button to adjust the balance between the left & right speakers.

10. Fader

Press SEL Button repeatedly until the display shows "FAD F-R"; then use the VOL +/- Button to adjust the balance between the front & rear speakers.

11. Clock

The time clock can be set anytime when the power is on. Press the CLK Button on the faceplate or remote control once, the time will show on the display.

Then press and hold the button until the hour blinks on the display. Rotate the VOL knob to set hours, then press the VOL knob for the minutes to blink and rotate the VOL knob to set.

Press the CLK button again or leave the unit idle for new setting to effect. Press the CLK button anytime to view the time clock display.

12. Preset Beep Sound Off

Press the SEL button repeatedly until "BEEP ON" is displayed. Turn the VOL +/- Button to select "BEEP OFF" or "BEEP ON"; then leave the unit idle for setting to take effect.

13. Preset Equalizer Function

Press the SEL Button repeatedly until "EQ" indication is displayed then rotate the Volume knob to choose between the EQ sound effects. The Sequence of equalizer setting will be as follows:

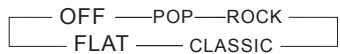

14. Dual Color Select

Press the SEL knob repeatedly until the display shows "Colour 1" or "Colour 2". Turn the volume knob to select between "Colour 1" or "Colour 2".

Radio Operation

1. Choose Radio Band

Press the MODE Button to access the radio function.

The unit comes with five bands - three FM Bands (FM1, FM2, and FM3) and two MW Bands (MW1, and MW2) selects. Each of the five bands can store up to six preset stations, for a total of 30 preset memory stations.

2. Radio Tune / Seek Function

In Radio Mode, press and hold the SEEK |<< or >>| Button for 2 seconds, and the display will show "MANU SEEK". Press the SEEK |<< or >>| Button once to manually adjust the radio frequency.

3. Tuning

Press the SEEK |<< or >>| Button once and the radio will seek the next strong and clear frequency station. Repeat to seek more stations in your listening area with a strong signal.

4. Mono / Stereo Reception Control

In FM radio mode, press the SEL button repeatedly until the display shows "STEREO" or "MONO". Turn the volume knob to change between STEREO or MONO. Improvement of reception of distant stations can be done by selecting "MONO" operation which may cut down some reception noise.

5. Save Your Preset Stations

There are six numbered preset buttons which can store and recall stations for each band. While listening to a radio station you would like to save as a pre-set, press and hold one of the buttons numbered 1-6 until you hear a beep. The button you pressed is now the pre-set button for that station.

6. Automatic Store / Preset Scan

There are six numbered preset stations which can store and recall stations for each band. While listening to a radio

station you would like to save as a preset, press and hold one of the buttons numbered 1-6 until the number of the radio change to the number you selected. The button you pressed is now the pre-set button for that station.

A. Automatic Scan & Store

While listening to the FM radio, press and hold the F/PS Button. The receiver will automatically scan and save stations of the 3 FM Bands.

While listening to the MW Radio, press and hold the F/PS Button. The receiver will automatically scan and save stations of the 2 MW Bands.

B. Scan & Preview Saved Stations

Press the F/PS button once, the receiver will scan the radio stations in the current band.

Radio Operation

1. AF-Alternative Frequency

Press the AF button so that the unit will choose the strongest FM signal for the selected station, so that you do not have to re-tune the stations when driving between different transmitter coverage areas. When AF is on, it means RDS information is received; when AF is flashing, it means RDS information is not yet received.

2. TA - Traffic Announcement

Press the TA button so that the unit will be activated for reception of traffic announcement from local radio stations.

To choose the TA mode, press the sound select button for 2 seconds, the display will show TA SEEK. Rotate the encoder volume to choose between the TA SEEK and TA ALARM, after choosing, please leave the unit idle for the mode to activate. In TA SEEK mode, the unit will seek for traffic announcement programme when TA is pressed; in TA ALARM mode, no TA/TP is displayed and the alarm is set off.

3. PTY - Programme Type

This radio will allow you to select the type of programme required, and will search for a station broadcasting that type of programme. Press the PTY button once to show the music type. Then press 1-6 button to choose the different music types available.

Press the PTY button twice to show the speech type programme. Then press 1-6 button to choose the different speech type programme. Each number key will show 3 different speech programme for you to choose.

4. MASK DPI - MASK ALL

Press the sound select button for 2

seconds, the display will show TA SEEK. Press the sound select button again so that the unit will show MASK DPI. Rotate the encoder volume to toggle between MASK DPI and MASK ALL mode. Then leave the unit idle for the mode to take effect. During MASK DPI mode, the unit will mask only the AF which has different PI, this is the default mode; during MASK ALL mode, the unit will mask the AF which has different PI and no RDS signal with high field strength.

5. RETUNE S/L - SHORT/LONG

This function is to set the initial duration of automatic TA Search-- Press and hold the sound select button until "TA SEEK" is shown on the LCD, then press the SEL button to cycle through the menu selections until "RETUNE_S" is shown, Rotate the encoder volume to choose "RETUNE_S" or "RETUNE_L". The default is "RETUNE_S".

RDS Operation

RDS-EON CONTROL

This unit is equipped with the latest technology of EON control, so that when you are listening to Radio or CD, and there is a travel announcement from a nearby local station, the radio will already know the frequency of that radio station. Then it will receive the station, turn up the volume, or interrupt the playback of the music for the duration of the announcement. At the end of the announcement the radio will return to its previous state ready for the next announcement.

Bluetooth Operation

1. Pairing

Press and hold BND/ID3/TEL button until the word "PAIRING" blinks on the display waiting for the bluetooth device to connect.

At this blinking time, please run the bluetooth search and connect function in your mobile phone. The car radio model no "BT Car Stereo" will be shown on the mobile phone. Select this car radio and connect. When you are asked for a connection password, please input "0000" in your mobile phone to finish the pairing, there is "PAIR OK" to show on the LCD. Then the bluetooth icon will be shown on the car radio LCD indicating that the bluetooth function is ready to use.

2. Dial

Press and hold BND/ID3/TEL button enter PHONE mode, you could dial telephone number " 0-9, *,# " button on the remote control.

You could turn VOL+/- to setup the speaker volume during you are on the phone.

3. Call Record

After Connection with mobile phone, under PHONE mode, then press SEL button and display until show DIAL (8 recent dialed number).

Press the SEL button again, RECV (8 recent received number) will show.

Press the SEL button again, MISS (5 recent missed number) will show on the display.

In each category, press |<< and >>| to view the saved telephone number.

4. Disconnection

Press and hold MOD / "Answer" button (with green phone logo), it will disconnect the phone.

When you press and hold MOD/"Answer" button(with green phone logo) again, it will connect the phone.

5. Answering/Rejecting call

When there is phone calling in, press the MOD/"Answer" button(with green phone logo) anytime to receive a call in your car radio. If you want to reject the call, press F/PS/ "REJECT" button(with red phone logo).

6. BT Audio (A2DP)

Press MOD/(with green phone logo) button, you could enter mode: Radio/CD/AUX/BT Audio. BT Audio will automatically play when you play the song in the mobile phone. You could pause by " ►II " button, to choose up and next song by pressing |<< and >>| button.

7. Auto Connect

This unit support the "Auto Connect function". In case the connected mobile phone is out of range (e.g. the user leaves the car for lunch), when the mobile phone is in the range again, the unit will automatically connect with the mobile phone so that you do not have to set connection in the mobile phone. If the auto connect does not work, press the "Answer" button(with green phone logo) so that the unit will connect to the last device(mobile phone). "Auto Connect" requires the function is enabled in your mobile phone as well.

CD/MP3/WMA/USB/SD Operation

1. Insert / Eject CD

Insert a disc into CD slot with label side up. The disc will be automatically loaded into the unit, even when it is off or at radio mode. The word "LOAD" will blink on the display and the CD will play automatically. Press the EJECT Button to eject the disc from the slot. If the disc is not removed from the slot within 5 seconds, it will automatically be loaded into the slot again. When the disc is ejected and removed, the unit will automatically switch to radio mode.

While you are playing a disc with MP3 or WMA, The first file in the root folder will be played. As the file is playing "MP3" or "WMA" will be displayed first, then if there is any ID3 information that will be displayed as the file is playing.

To play MP3/WMA files from a USB flash memory, insert a USB flash memory into the USB port on the left side of the unit. The unit will start playing MP3/WMA files on the USB flash memory automatically.

If the MP3/WMA files are stored in folders on the USB drive, the unit will start by playing the first song in the first folder. After playing all the files sequentially in the first folder, the unit will play sequentially all of the files in the next folder. The unit will continue playing through all of the folders on the USB drive in this manner.

If the USB drive has loose files and folders containing files, it will play the loose files sequentially, then it will play the files in the folders sequentially.

2. Multi-Session CD Reading

This unit can read multi-session CDs. The multi-session reading will be activated automatically if the player detects a file that is written in multi-session format.

3. Selecting Tracks

Press the SEEK >>| Button to advance CD to the next track. Track numbers will be shown on the display. Press and hold SEEK >>| to fast forward. Press the SEEK |<< Button to go to a previous track. Track numbers will be shown on the display. Press and hold the SEEK |<< Button to fast reverse. Disc will play normally when the No. 1 (play/pause) Button is pressed.

4. Play / Pause CD

Press the No.1/PAU Button to pause the CD. PAUSE will show on the screen. Press this button again to resume playback.

5. Introduction

Press the No.2/INT Button to play the first 10 seconds of each track. "INT ON" will be shown on the display. Press this button again to resume playback. "INT OFF" will be shown on the display.

6. Repeat

Press the No.3/RPT Button to repeat the current track. RPT ON will appear on the display. Press it again to cancel. "RPT OFF" is shown to indicate it is cancelled.

7. Random

Press the No.4/RDM Button to play all the tracks in random order. "RDM ON" will appear on the display. Press this button again to stop random play. RDM OFF will appear on the display.

8. FOLDER + (for MP3/WMA only)

Press the No 6/FOLDER+ Button to choose upper folder from current folder.

9. FOLDER - (for MP3/WMA only)

Press the No 5/FOLDER- Button to choose next folder from current folder.

CD/MP3/WMA/USB/SD Operation

10. Search Modes

There are 3 search modes to help find your favorite MP3 & WMA tracks. The search modes only works with MP3/WMA CDs, and USB flash memory with MP3/WMA files.

A. Simple Track Search

Press the SEEK |<< or >>| Button to go to the next track or previous track.

B. Track Search

Press the F/PS Button, TRK-SCH will appear on the display. Use the VOL +/- Button to select the track number. Press and hold the SEL button for 2 seconds, the number of the track is assigned according to you added the file into the media. The file which are written later will be assigned a larger number.

C. Folder Search

Press the F/PS Button and NAVIGATE will be shown on the display. Use the VOL +/- Button to select the folder name. Then press the SEL Button to play the chosen folder.

11. Electronic Shock Protection

Electronic Shock Protection is for driving on rough roads. The CD will play for 10 seconds on rough roads without skipping, if driving on a rough road for more than 10 seconds the CD may skip. For MP3 or WMA files will play for 120 seconds. If the road is rough for more than 120 seconds the CD with MP3 or WMA files may skip.

ID3 Tag

If an MP3 file has ID3 Tag information, it will be displayed on the LCD. If there is no ID3 Tag information, nothing will shown on LCD.

MAINTENANCE

Cleaning the Unit

Do not use any liquids to clean this unit.

Do not use petroleum distillates to clean this unit.

Use a clean, dry cloth to clean this unit.

Replacing the Fuse

Make sure the amperage matches the specified value when replacing the fuse(s). If the fuse is bad, check the power connection and replace the fuse with a new one. If the same problem occurs, this might indicate a malfunction within the unit.

Warning

When replacing a fuse, do not use a fuse with a higher amperage rating than the fuse originally supplied to your unit, otherwise damage will result to your unit.

RCA, AUX & SUB

1. Auxiliary Input

The Auxiliary Input Jack is on the front panel. Insert the AUX IN cable's stereo plug into the AUX IN jack on the panel of the unit. Route the other end of the stereo plug to the headphone jack of any external audio device such as walkman and discman. Press the Mode button to choose AUX. Connect any portable audio device such as a DVD player or VCD player to the AUX IN cable. Use the volume control to adjust volume.

2. RCA Output

The RCA Output Jack is on the back of the unit. (Refer to Wiring) This output is for connecting amplifier, equalizer, or other audio component that requires a pre-amp out connection.

(Red = Right, White = Left) Follow the manufacturers instructions for the audio component that you are connecting.

3. Subwoofer Output

The Subwoofer Output Jack is on the back of the unit. (Refer to Wiring) This output is for connecting up to 2 subwoofer amplifiers. You must connect an amplifier to the Subwoofer Output Jack to drive a subwoofer. Follow the amplifier's installation instructions. Press the BND/SUB button to activate subwoofer control. Press the button again to turn it off.

FAQ

PROBLEM	CAUSE/SOLUTION
No Power	Check wiring connections. Check and make sure the fuse is not blown. Replace with the proper rating/size fuse.
Some errors occur in the LCD or no functions when buttons are pressed.	Press the RESET Button (21).
Unable to receive stations	Check and make sure the antenna is connected properly.
Poor radio reception	Check and make sure the antenna is the correct length. Make sure the antenna is not broken. If the antenna is broken, replace it. The antenna is poorly grounded. Check and make sure the antenna is grounded at mounting location.
CD's cannot be loaded	A CD is already loaded in the player. Eject CD.
Songs keep skipping	The CD is dirty or damaged.
File information shows in LCD but will not play.	If you have files with Digital Rights Management(DRM). Contact the vendor for proper use.
MP3/WMA files on the USB/SD flash memory do not play.	Flash memory is formatted as NTSC. Format the flash memory as FAT or FAT32. The files have Digital Rights Management (DRM). If the files you are attempting to play were purchased online, they may have Digital Rights Management, this unit is not DRM compatible.



Bluetooth Car CD/MP3 Radio

WARRANTY CARD

Congratulations! You have made an excellent choice with the purchase of this quality product. Our commitment to quality also includes our service. Should you, contrary to expectations, experience defects due to manufacturing faults during private use within 36 months of the date of purchase we shall be liable for warranty in accordance with statutory warranty regulations provided that:

- the device was not put to any use other than the intended
- was not overloaded
- was not used with the wrong accessories
- repairs were not carried out by any other than the authorised workshop

The warranty certificate is only valid in connection with the receipt. Please keep both in a safe place. This warranty does not affect your statutory rights.

This purchase is guaranteed for a period of three years beginning on the day of purchase. Keep your purchase receipt safe as proof of date of purchase. The guarantee can only be extended for the duration of any repair required.

Should your item become defective during the warranty period, in the first instance please call our service centre on the number below, they will then inform you of what to do next. We will at our discretion, either repair or exchange the device in accordance with warranty legislation.

Please enclose the following when sending your product in for repair:

1. Receipt (proof of purchase)
2. This warranty certificate with the fault report form overleaf complete with your name, contact details and fault description.

If the original receipt is not enclosed the repair will be charged in all cases. After the warranty has expired you can still send defective devices for repairs to the address stated below. Quotes as well as repairs after the warranty period are to be paid in all cases.

Ensure that the product is sent well packed as no responsibility can be accepted for items lost or damaged in transit.

This warranty does not affect your statutory rights.





**Bluetooth
Car CD/MP3 Radio**

FAULT REPORT CARD

Name _____

Address _____

Email _____ Daytime Tel No _____

Model Number 43744 _____

Fault Description _____

Service Hotline:

QESH LTD,
1 Solway Court, Electra Way, Crewe Business Park, Crewe CW16LD, UK
HELPLINE UK/N. IRELAND - 01270 508538
HELPLINE REP. IRELAND - 1800 995 036
WEB SUPPORT: www.qesh.co.uk